

Heavy Plate and Beam Edge Preparation Machines

For extra long parts only.

Shortest part: approx. 1 metre. Longest part: No limit
 These machines are for the steel construction industry, bridge builders and ship builders. Heavy, long plates.

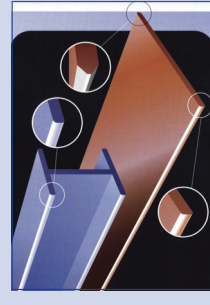

Parts can be radiused, chamfered or bevelled.

Friction Deburring Machines

Shortest part size approx. 20mm
 Friction Deburring machines are most effective on flame cut blanks with scale and dross.

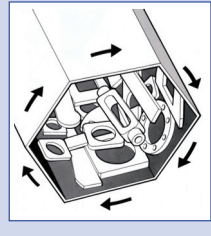

Rotating drum de-slugging machine. 600kg capacity. 20 min cycle time. Will process mixed parts of all sizes.

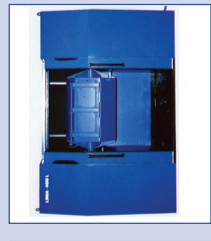

Marbling Machines

Shortest part size 500mm.
 Minimum 150mm long. With jigs, magnets or vacuum. Maximum width 1500mm.



Model



Close up of the marbling head.

Deburring and Graining



Gritty says . . .

No stainless sheet deburring and edge rounding machine can also produce a grained finish.

Professional grained finishes are applied by special wide belt machines with billy rolls. Standard wide belt machines do not have billy rolls.

Even if you used a billy roll machine after the deburring machine the results would not be acceptable because the rounded corners would be sharp again. The answer is to buy professionally grained sheet with a protective film.

Lissmac machines deburr and round edges without damaging the protective film.

What Finish?

Grained Finish

Achieved with abrasive belts between grit 80 and 240.

A grained finish has a straight in-line scratch pattern, more or less pronounced by the abrasive belt grit size used.

The 'colour' of the grained finish is determined by the abrasive belt grade used: aluminium oxide, ceramic or silicon carbide. Professional wide belt graining machines have a billy roll which standard wide belt machines do not have.

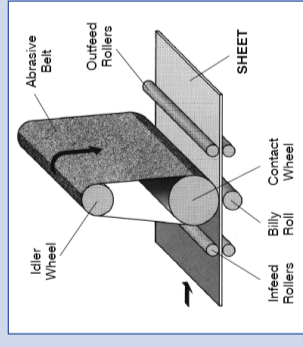
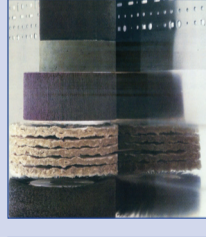

Diagram of a 'billy' roll graining machine.

Brushed Finish

Achieved with abrasive cloth brushes.

The brushed finish is similar to the grained finish but the scratch pattern is not straight in-line but at random and finer.



Model LSS0 Buffer.

Model FBR. Reciprocating table brushing machine. Some of the brushes used for a brushed finish.

Swirl Finish

Left by planetary abrasive discs.

Planetary abrasive discs and brushes are excellent tools for deburring, because they reach all edges on holes and cut outs. However, they leave a swirl finish and not an in-line grained finish.



Model DiscMaster ATD Abrasive disc deburrer. For one sided deburring only.



Two examples of planetary disc heads with multiple brushes.

Mirror Finish

We refer to a mirror finish when the surface is blemish free and reflective.

A full 'No.8' mirror finish can only be produced with dedicated machines and is expensive.

Often, a 'commercial' mirror finish is acceptable. It can be produced with cheaper machines and in a shorter time.

With structured abrasive belts, extremely fine finishes can be achieved but reflectivity is low and a buffing operation must follow.



Model ROM. Top class mirror polishing machine, either with reciprocating table or head.

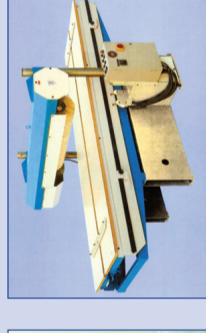

Model FBR. Budget mirror polishing machine with reciprocating table.



Manual mirror polishing machine.

Deburring of sheet covered with protective tape

Several of our machines will deburr without damaging the tape as long as the tape is of good quality.



Model SBM-S is the best machine for deburring sheet covered with protective tape or for plated sheet.



Planetary disc machines will also not damage the tape.

Marble Finish

Produced with special design dedicated marbling machine and abrasive discs.



Model Combi III. For automatic marbling and application of protective tape.

Uneven Bevel Finish

Produced with bevelling machine with vertically arranged milling cutters.

These machines will leave a finish with chatter marks.



Model SKF. Portable bevelling machine.



Model 650. Bench chamfering machine with milling cutters.



Model CHP12. Self propelling bevelling machine with rotary shear cutter.

Smooth Bevel Finish

Smooth bevels can only be produced with bevelling machines with abrasive discs or horizontal milling cutters.



Model ASO 650 Bench chamfering machine with grinding wheel or special horizontal cutter.



Model KMW Abrasive belt edge bevelling machine.



Model AC43 Bench chamfering machine with abrasive disc.

Surtech

What Edge? What Size? What Finish?

A short guide to sheet metal deburring equipment

What Edge?

1. Removing dross from flame cutting

Manual dross removal is a dirty and noisy job with some Health and Safety implications. The following machines considerably improve working conditions.

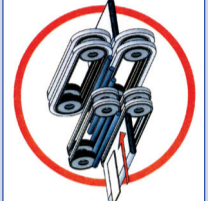
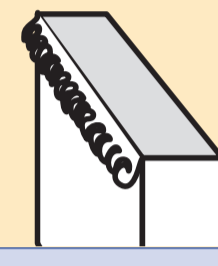

Semi automatic dross removal machine suitable for small batches.

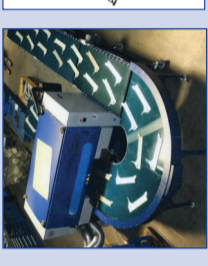

Model SBM-GS. Four belts on top side and four belts for bottom side.

2. Removing burrs from laser cutting, guillotining, sawing and punching

With modern cutting equipment burrs are relatively light but still have to be removed for safety and technical reasons. Automatic deburring machines are available to produce a variety of edge configurations.

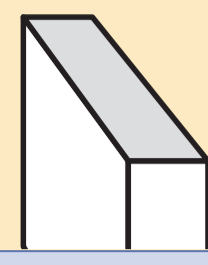
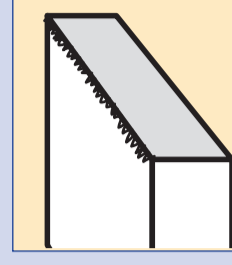

3. Burr removed but corners still sharp

Single head wide belt machines have been the most widely used method to remove burrs from sheet metal and plate over the last 25 years. They do, however, leave sharp edges and cannot produce the rounded edges demanded today.



Wide belt deburring machine with one head.

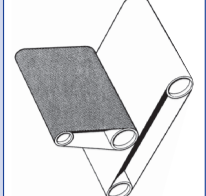

Diagram of wide belt machine with one head.

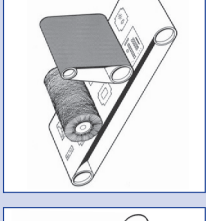
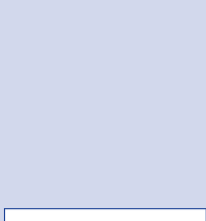
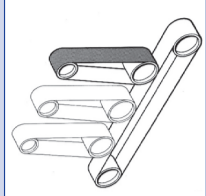

Diagram of a wide belt deburring machine with one or two brush heads. Will produce better edge finish but still not the same rounded corners as dedicated machines.



Narrow belt machines are available with up to three heads.



Narrow belt, single head deburring machine. For the occasional sheet deburring, consider using a portable abrasive power tool with a special cranked arm.

What Edge?

1. Removing dross from flame cutting

Manual dross removal is a dirty and noisy job with some Health and Safety implications. The following machines considerably improve working conditions.

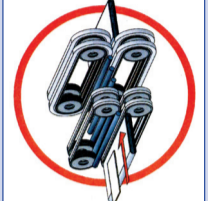
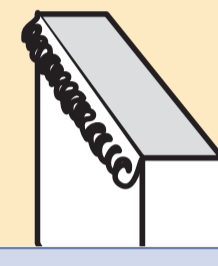

Semi automatic dross removal machine suitable for small batches.

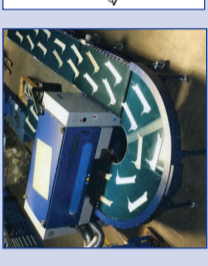

Model SBM-GS. Four belts on top side and four belts for bottom side.

2. Removing burrs from laser cutting, guillotining, sawing and punching

With modern cutting equipment burrs are relatively light but still have to be removed for safety and technical reasons. Automatic deburring machines are available to produce a variety of edge configurations.

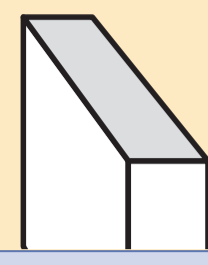
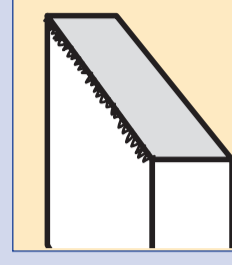

3. Burr removed but corners still sharp

Single head wide belt machines have been the most widely used method to remove burrs from sheet metal and plate over the last 25 years. They do, however, leave sharp edges and cannot produce the rounded edges demanded today.



Wide belt deburring machine with one head.

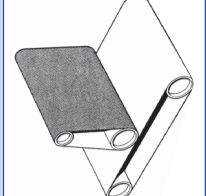

Diagram of wide belt machine with one head.

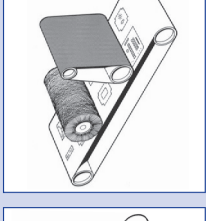
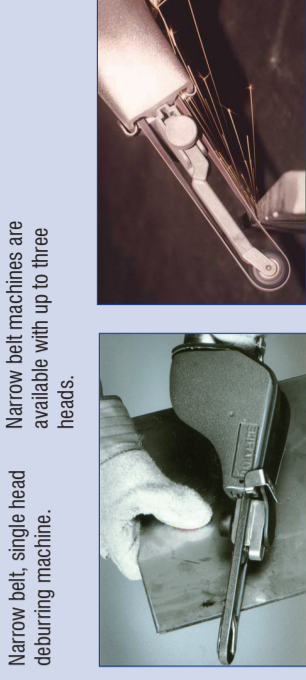
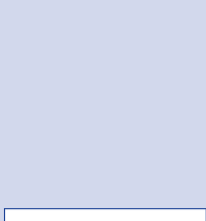
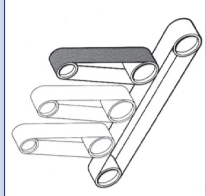

Diagram of a wide belt deburring machine with one or two brush heads. Will produce better edge finish but still not the same rounded corners as dedicated machines.



Narrow belt machines are available with up to three heads.



Narrow belt, single head deburring machine. For the occasional sheet deburring, consider using a portable abrasive power tool with a special cranked arm.



For further information contact:

Surface Technology Products Ltd.

244 Heneage Street, Birmingham B7 4LY

Telephone: 0121 359 4322 Fax: 0121 359 1817

Email: sales@surtech.co.uk www.surtech.co.uk

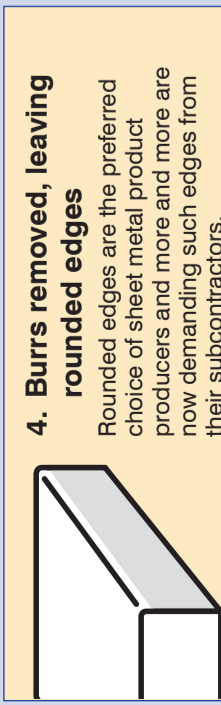

4. Burrs removed, leaving rounded edges

Rounded edges are the preferred choice of sheet metal product producers and more and more are now demanding such edges from their subcontractors.

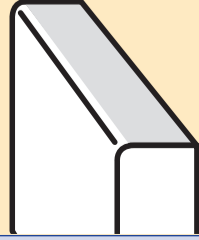

5. Burrs removed, leaving radiused edges

The small radius edges are slightly more rounded than the rounded edges. This can only be achieved with abrasive planetary discs or rotary brushes combined with a planetary drive. The number of heads determines the amount of rounding or radiusing.

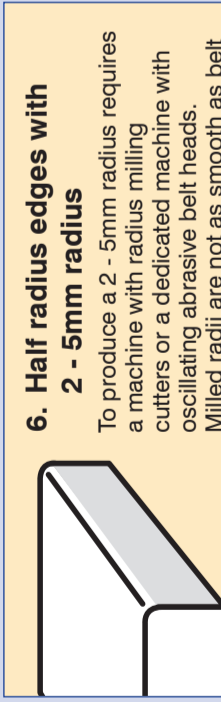

6. Half radius edges with 2 - 5mm radius

To produce a 2 - 5mm radius requires a machine with radius milling cutters or a dedicated machine with oscillating abrasive belt heads. Milled radii are not as smooth as belt ground radii.



A portable radiusing machine with milling cutters to produce 2mm to 5mm radius.



An extra heavy duty portable machine with oscillating belt heads. For long parts.

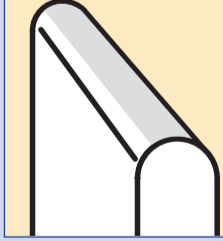

7. Full radius edges

Full radii can only be produced with portable or stationary machines using radius milling cutters. For long parts it is possible to use special machines with oscillating abrasive belt heads. Milled radii are not as smooth as belt ground radii.



Fully automated machine for chamfering and radiusing of long parts.



Typical parts for edge chamfering and radiusing using machine on left.



An extra heavy duty portable machine with radius milling cutters.



Extra heavy duty pedestal chamfering / bevelling machine.



Special design abrasive belt head with oscillating contact rollers for producing a radius.

The Surtech method of describing Bevel sizes and Bevel angles

Please adhere to these descriptions to avoid confusion and mistakes.

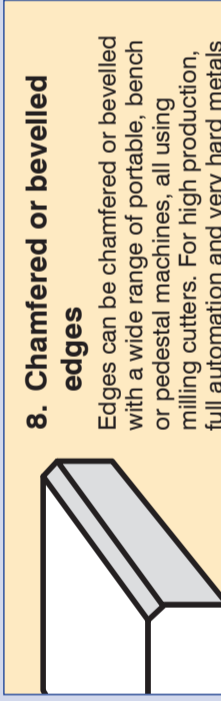
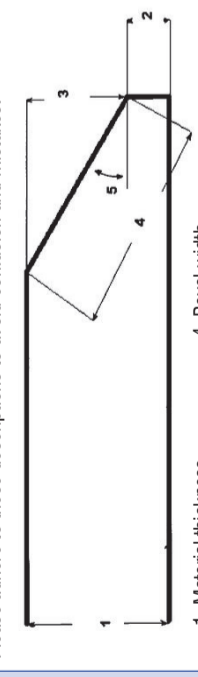

8. Chamfered or bevelled edges

Edges can be chamfered or bevelled with a wide range of portable, bench or pedestal machines, all using milling cutters. For high production, full automation and very hard metals we can offer dedicated abrasive belt machines. Milled chamfers are not as smooth as belt ground chamfers.



Extra heavy duty self-propelling chamfering machine. With milling cutters. Max bevel 20mm.



Bench model chamfering machine. With milling cutters. Max bevel 7mm.



Portable chamfering machine. With milling cutters. Max bevel 12mm.

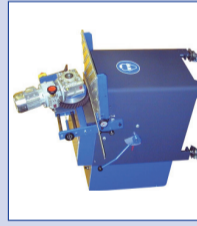

Pedestal chamfering machine. With milling cutters. Max bevel 20mm.



Abrasive belt chamfering / bevelling machine. Max bevel 40mm.

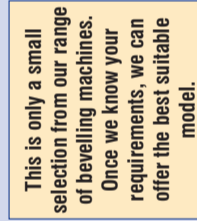

This is only a small selection from our range of bevelling machines. Once we know your requirements, we can offer the best suitable model.

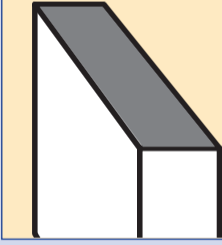

9. Oxide removal from edges

If you cut mild steel using oxygen, you will often have to remove the black oxide film left by this method. Most users of plate now insist that their subcontractors supply oxide free edges. Our dedicated machines are used by leading Companies.

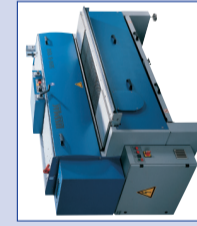

Model SBM-B Dedicated wire brush belt machine. For removing oxide film from edges.



Special wire brush belt used in the oxide removal machine on the left.

What Size?

Part sizes are an important factor in the choice of machine. Small parts are often the most labour intensive to deburr but unfortunately manufacturers do not state the smallest parts that can be processed and when they do the figure is often not a true one or one that is only achievable with jigs, vacuum or magnets and not really suitable for industrial production. Some rules of thumb governing the minimum sizes of parts that can be processed:

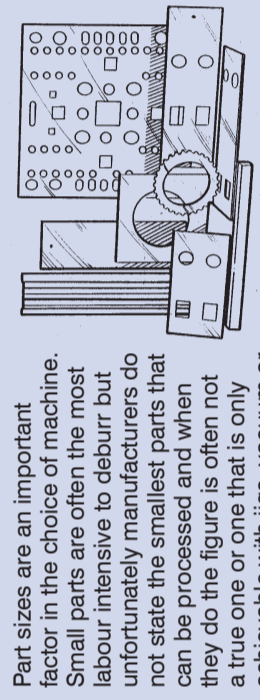

Narrow and Wide Belt Throughfeed Machines

Shortest part size 180 - 280mm without jigs, vacuum or magnets. Approx 30mm with jigs, vacuum or magnets.



Wide belt machine.

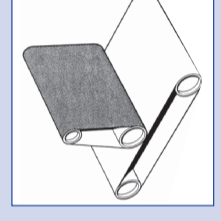

Diagram of a wide belt machine.



Narrow belt machine.

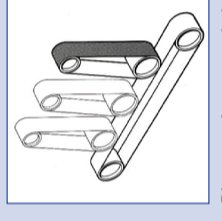

Diagram of a narrow belt machine.

With narrow belt or wide belt machines it is the distance between the centre of the hold down roller before the contact wheel and the centre of the hold down roller after the contact wheel.

We consider narrow belt machines as having 150mm, 200mm, or 300mm wide belts and wide belt machines as having 600mm, 900mm, 1100mm, 1300mm and 1500mm wide belts.



Wide belt throughfeed machine showing contact wheel and two hold down rollers.

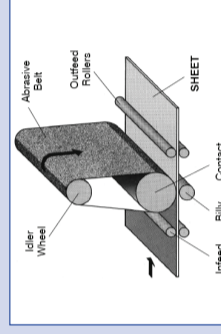

Diagram of a wide belt throughfeed machine showing contact wheel and two hold down rollers. In this case called infeed and outfeed rollers.

Depending on the machine and the diameter of the contact wheel, the shortest parts that can be processed is from 180mm to 280mm. In some cases shorter parts will work with a special grade conveyor belt, low contact pressure and a clean environment. Dust on the conveyor belt will reduce friction and parts will not be held safely. If you want to process parts that are shorter than the distance between the two hold down rollers you will need a jig, magnet or vacuum, but not all machines offer the optional magnet or vacuum.

Narrow belt machines with a magnet can handle parts as short as 30mm. Wide belt machines normally do not have an optional

vacuum table over their entire width but only one narrow strip on the side.

With both narrow and wide belt machines the width is no problem. The max. parts width should always be approx. 10mm narrower than the abrasive belt width. Length is virtually infinite.

Cross Belt Machines

Shortest part size approx. 160mm

With cross belt machines, the abrasive belts run crosswise to the conveyor, across the width of the part. There are cross belt machines which only deburr one side and machines which deburr top and bottom side of parts in one pass.



A single sided cross belt deburring machine.



A top and bottom deburring machine.

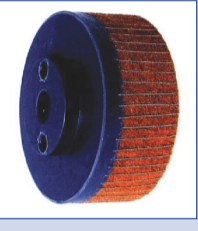

Diagram of a top and bottom machine.

Disc Machines

Shortest part size approx. 50mm

Some of the deburring discs used on both the in-line machines and machines with planetary disc drives:



Disc used for rounding corners on thin sheet metal.



Disc used for rounding corners of sheet and plate with min. thickness of 5mm.

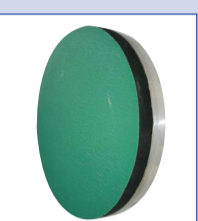

Disc used for removing surface contamination, oxide, scale, coatings, etc.



Diagram of Model CrossMaster with two hold down rollers.

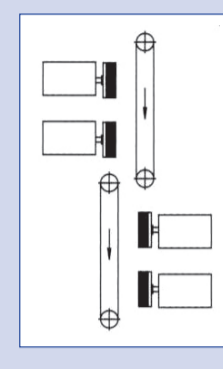

Diagram of Model CrossMaster with between one and three top and bottom disc brushes.

Cross Disc Machines with Reciprocating Discs

Shortest part size 20 x 20mm.

Widest parts as per max. working width of ??? Longest part virtually infinite.



Model DiscMaster 4TD.

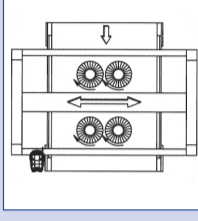
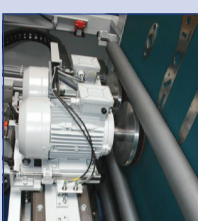

Diagram of DiscMaster with four disc brushes.



Showing the two disc heads running across the conveyor direction.

Planetary Rotary Brush Machines

Shortest part size approx. 50mm

With planetary rotary brush machines, each brush rotates in a vertical position to the conveyor and all brushes rotate together in a horizontal position.

This is the most effective way of deburring sheet with the most rounded corners.

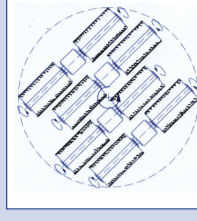

Diagram of planetary drive rotary brush machine.



The type of abrasive rotary brush used in planetary rotary brush machines. Consists of slashed abrasive cloth.

Long Belt Deburring Machines

Shortest part size approx. 30mm against stop

When parts are laid against a stop or jugged sizes as small as 50mm x 20mm can be processed. Part length depends on the table size of the machine. Up to 4000mm is standard, over 4000mm to order only. Max. width is between 700mm and 1000mm.



Diagram of a standard long belt machine with drive and idler wheel and with contact wheel or platen.



A single and a twin belt machine. With standard belt run and with triangular belt run.

Swing Grinder Deburring Machines

Shortest part size approx. 50mm x 50mm



Model Swing Grinder. Manually operated deburring machine.



The Swing Grinder uses the same disc deburring tools as the other disc machines.